

# 標準型

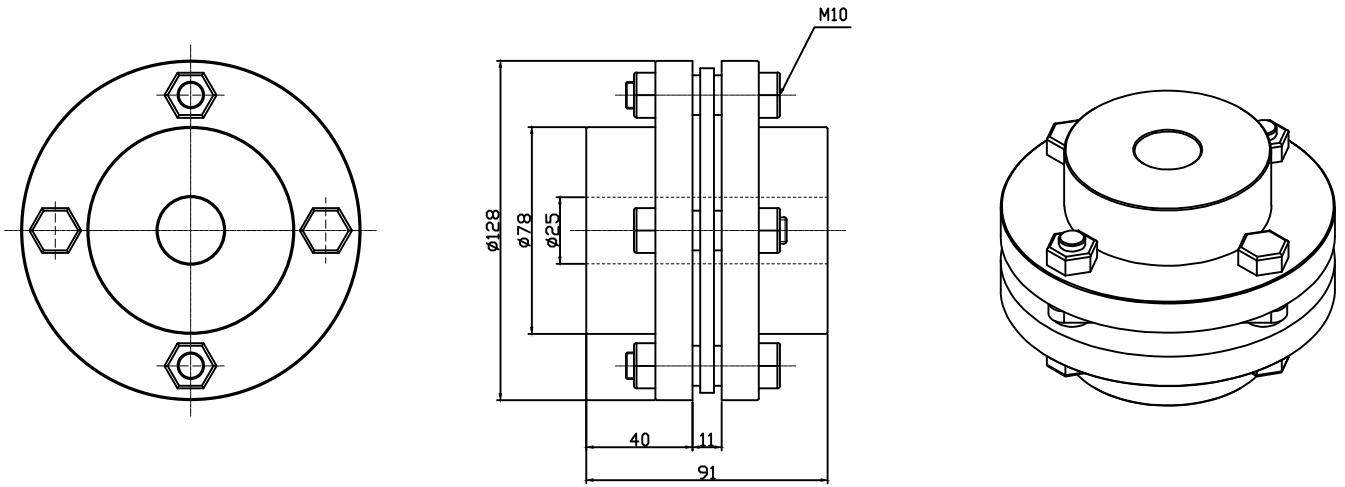

DWG NO. (PART NO.)  
SWP-128-25

# C型

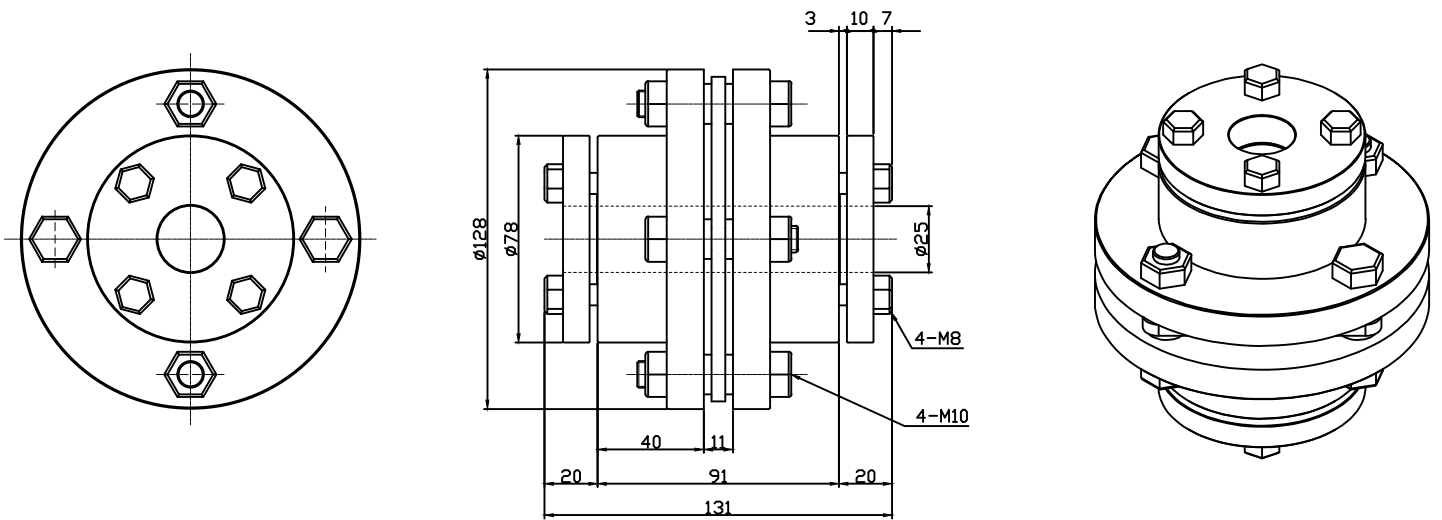

DWG NO. (PART NO.)  
SWP-128-25C-25C