

註：未標示之倒角為0.2-0.3C

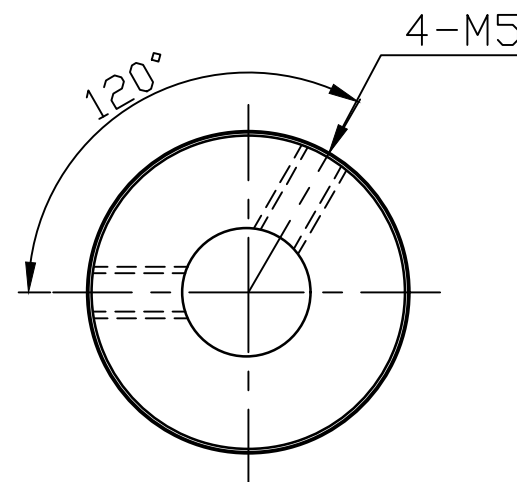
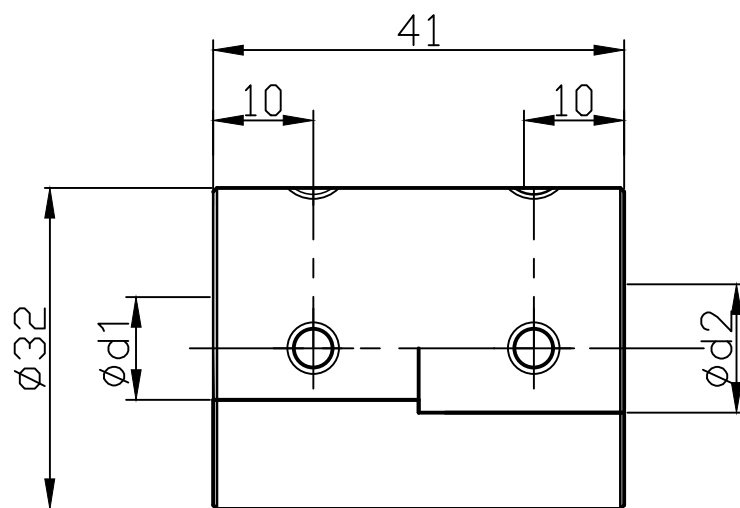

STOCK BORES: 8~16mm
TORQUE: 2~4N.m

DWG NO. (PART NO.)

SRCS-32-d1-d2