

註：未標示之倒角為0.2-0.3C

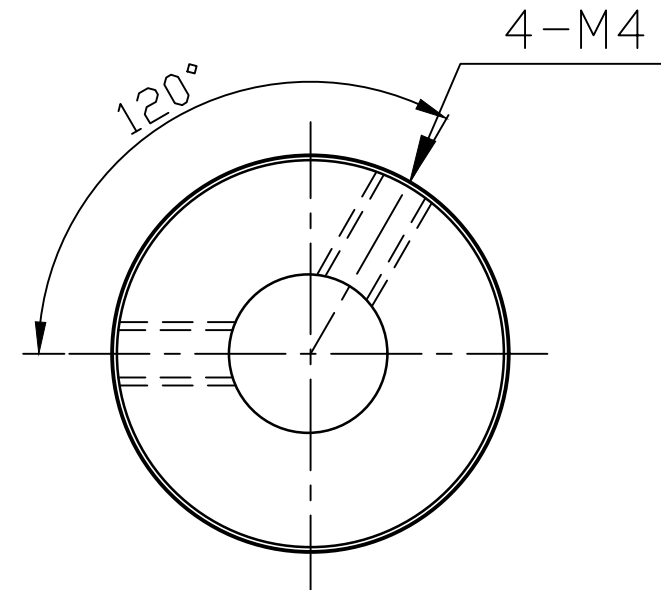
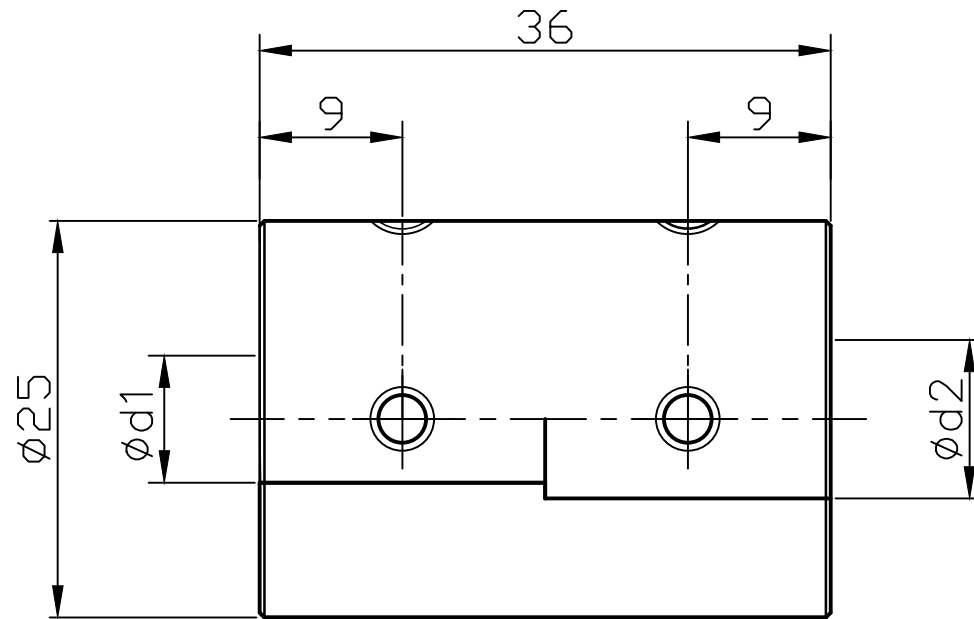

STOCK BORES: 6~12mm
TORQUE: 1~2N.m

DWG NO. (PART NO.)

SRC-25-d1-d2